

Human proBNP, BNP and NT-proBNP

Brain natriuretic peptide (BNP) and the N-terminal part of the BNP precursor proBNP (NT-proBNP) are established diagnostic and prognostic biomarkers of heart failure (HF). HF is a severe clinical and public health problem that is characterized by an increasing prevalence and economic cost. According to the American Heart Association, its prevalence extends to 6.5 million people in the United States with nearly 1 million new cases being reported each year (1); on a global level, the prevalence reaches more than 23 million people. Chronic heart disease, hypertension and diabetes are among the known risk factors and the prevalence of HF is also higher for those people aged over 65 years. HF is associated with significant morbidity and mortality.

BNP, NT-proBNP and proBNP as diagnostic markers

Clinical guidelines recommend measuring either BNP or NT-proBNP in order to rule out HF in the initial assessment of a patient with suspected acute heart failure. Both markers can also be used to monitor the progression of the disease. The clinical values of BNP and NT-proBNP are similar (2-3) and both markers are currently used in clinical practice.

In healthy adults, the upper limit of BNP in plasma is 35 pg/ml and that of NT-proBNP is 125 pg/ml (4). However, the values depend on age and gender, and are higher in elderly people and women.

The concentrations of the analytes correlate with the severity of the disease and can increase by up to several hundred-fold. It has been reported that both peptide concentrations are already elevated in asymptomatic patients during the very early

stage of heart failure (NYHA I stage according to the New York Heart Association classification). NYHA classes II and III, and especially class IV patients, demonstrate significantly elevated concentrations of BNP and NT-proBNP in their blood. Therefore, peptide measurements in human blood are widely used for the evaluation of patients with suspected HF and when assessing the severity of the disease.

Determining BNP or NT-proBNP concentration is also useful for the risk stratification of the patients with different cardiac pathologies. Patients who will develop complications in the future are characterized by significantly higher BNP and NT-proBNP concentrations than those patients without complications. In patients with congestive HF, high BNP or NT-proBNP levels predict death and are relevant to cardiovascular risk. Meanwhile, in patients with acute coronary syndrome, elevated levels of both peptides are predictive for mortality and severe HF.

In addition to NT-proBNP and BNP, their precursor proBNP1-108 is also found in significant amounts in the blood samples derived from HF patients. Assays detecting only proBNP might have an enhanced analytical specificity.

CLINICAL UTILITY

- **Identification or exclusion of HF**
- **Assessment of the severity of HF**
- **Prognosis of the disease development**
- **Monitoring of drug therapy in the presence of HF**

Biochemistry of proBNP and its derivatives

The gene encoding for BNP is activated in cardiomyocytes in response to myocardial stretch due to pressure or volume overload. This results in the synthesis of a 134 amino acid residues (a.a.) long intracellular precursor prepropeptide preproBNP. Following the removal of the signal peptide, further processing of the propeptide results in the release of the biologically active BNP (32 a.a.) and NT-proBNP (76 a.a.) which has no known biological activity. Both BNP and NT-proBNP as well as unprocessed proBNP are secreted into the bloodstream and circulate in human blood (see Figure 1). BNP is efficiently cleared from the circulation and its half-life is approximately 20 minutes. The half-life of NT-proBNP is longer – 60-120 minutes – which explains the apparently higher concentration of NT-proBNP vs. BNP in blood.

ProBNP is an O-glycosylated protein with seven identified glycosylation sites (5). All of the glycosylation sites are located on the NT-proBNP part whereas BNP is not glycosylated.

We have previously shown that the glycosylation status of one amino acid, T71, is crucial to the processing of proBNP into BNP and NT-proBNP. T71 is located close to the cleavage site and the convertase-dependent cleavage can only occur if T71 is not glycosylated. Consequently, the majority of the unprocessed proBNP found in circulation has an O-glycan on T71 whereas the same amino acid in NT-proBNP is not glycosylated (6).

Reagents for immunoassay development

At Hytest, we have been studying proBNP and its derivatives for several years. To this end, we have published several articles in peer reviewed journals (for further details, see pp. 10-11). We provide a broad range of well characterized monoclonal antibodies (MAbs) that allow for the development of sensitive and reliable immunoassays that are suitable for the detection of proBNP, NT-proBNP and BNP in clinical samples.

We also provide different recombinant antigens that can be used as standards and calibrators in immunoassays.

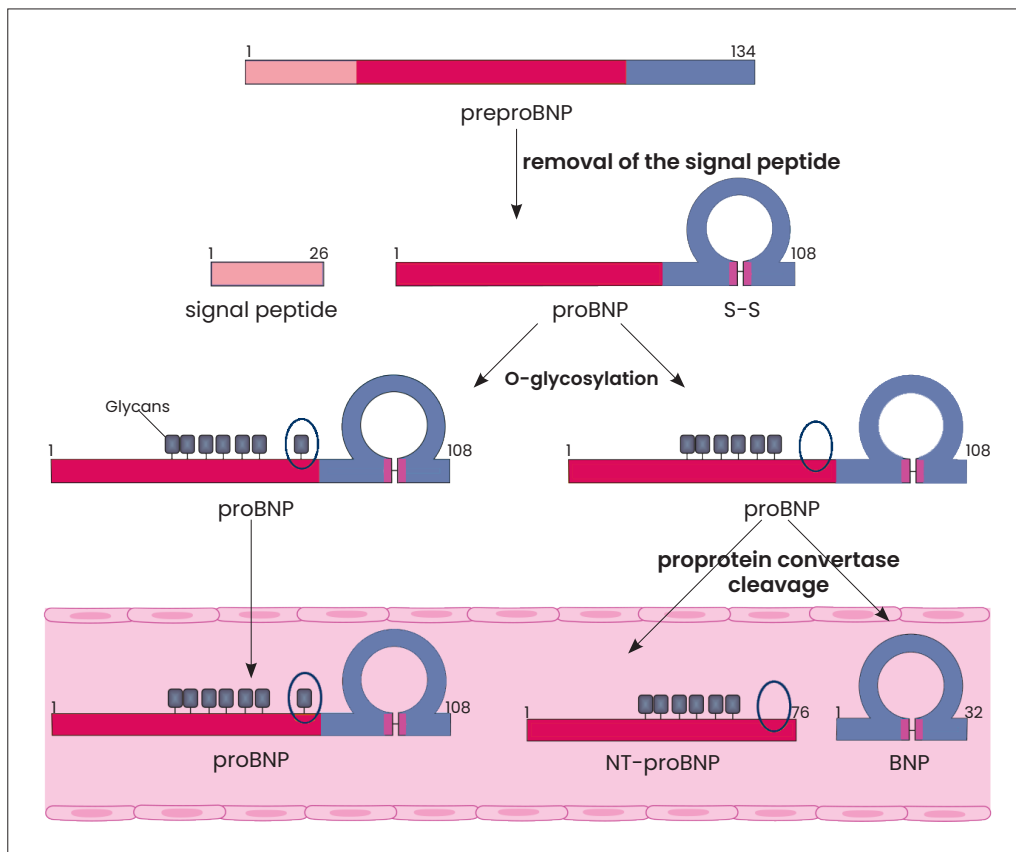

Figure 1.

Scheme of proBNP processing. ProBNP is formed following the translation and cleavage of the signal peptide of preproBNP molecule. It is then glycosylated at several sites. Two pools of proBNP that are different in the status of T71 glycosylation are formed: non-glycosylated at T71 and molecules glycosylated at this site. Glycosylation suppresses the subsequent processing of proBNP. Only proBNP that is not glycosylated at T71 can be effectively processed into BNP and NT-proBNP. Non-processed proBNP, NT-proBNP and BNP are released into the blood.

BNP ASSAY DEVELOPMENT

Human BNP is a 3.5 kDa peptide that is formed by the cleaving of proBNP into NT-proBNP (the N-terminal part) and BNP (the C-terminal part). BNP consists of the amino acids 77-108 of proBNP. However, in the BNP molecule, the amino acids are usually numbered as 1-32. The calculated pI of BNP is 10.95.

BNP is a peptide hormone with natriuretic, vasodilatory and renin inhibitory properties (7-9). It belongs to a family of structurally similar peptide hormones that also includes atrial natriuretic peptide (ANP), C-type natriuretic peptide (CNP) and urodilatin. These peptides are characterized by a 17 amino acid ring structure that is formed by a disulfide bond between two cysteine residues. The ring structure is highly homologous between the different natriuretic peptides with 11 out of 17 amino acid residues being identical among the peptides. In human BNP, the disulphide bond is between C10 and C26 (see Figure 2).

BNP is an unstable molecule

BNP is known to be an unstable molecule (10-11). Several studies have revealed that BNP is presented by multiple forms in the plasma from HF patients, being truncated from both N- and

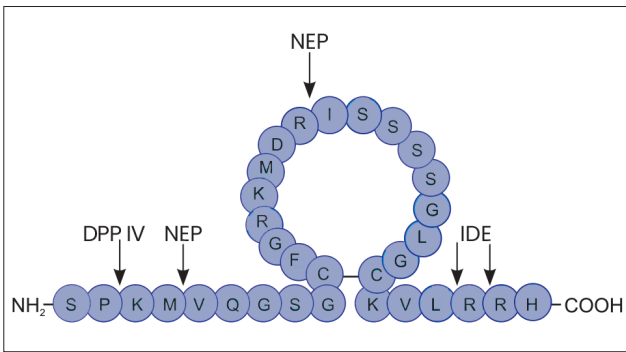

Figure 2. Schematic representation of human BNP and the main sites of its proteolytic degradation by different proteases. DPP IV is dipeptidyl peptidase IV, NEP is neutral endopeptidase (neprilysin), IDE is insulin-degrading enzyme.

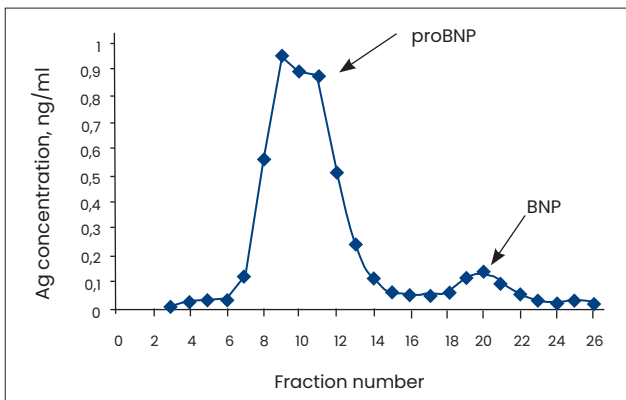

Figure 3. Gel filtration studies of endogenous proBNP and BNP. Proteins from one representative plasma sample of a HF patient were separated on the Superdex Peptide column (GE Healthcare). BNP immunoreactivity in fractions was measured by the 50E1-24C5 assay. The first peak corresponds to proBNP, while the second peak corresponds to the BNP form.

C-termini. Only a small portion of BNP circulates as a full-size BNP1-32 molecule (12). Proteases such as dipeptidyl peptidase IV (DPP IV) and neutral endopeptidase (neprilysin, NEP) have been reported to degrade BNP, which gives rise to BNP3-32 and BNP5-32, respectively (13-14). Some studies have suggested that insulin-degrading enzyme (IDE) can also degrade BNP into smaller peptides (15-16). The known sites of BNP proteolytic degradation are summarized in Figure 2.

BNP immunoreactive forms in human blood

As the cleavage of proBNP into NT-proBNP and BNP is only partial and depends on the posttranslational glycosylation of the protein, both BNP and proBNP are released into circulation. Both of these forms can be recognized by antibodies that are specific to the BNP molecule unless the epitopes are destroyed through truncation by proteases. We analyzed plasma samples from HF patients by using gel filtration and measuring the BNP immunoreactivity of the fractions through the use of a highly sensitive antibody pair 50E1-24C5 which is able to detect different BNP forms with equal specificity. The results of the gel filtration studies showed that the BNP assay detected two peaks with BNP immunoreactivity in all samples. The first peak represents the proBNP form while the second, smaller peak, represents the BNP form (see Figure 3). We have previously shown that the predominant BNP immunoreactive form in human blood is the unprocessed proBNP (17).

Conventional BNP sandwich immunoassays

We provide several MAbs that are specific to different epitopes on the BNP molecule (see Figure 4). Several different MAb combinations allow for the development of highly specific, sensitive and rapid conventional-type sandwich immunoassays that are suitable for the quantitative measurement of BNP and proBNP in human blood. Table 1 shows the recommended antibody pair combinations for conventional sandwich immunoassays.

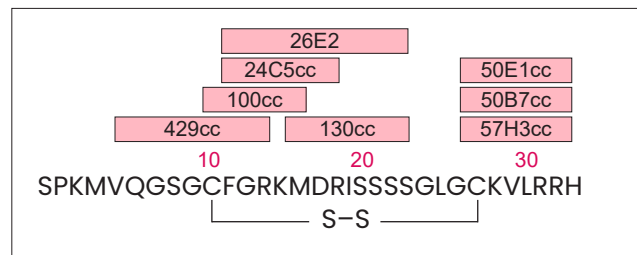

Figure 4. Epitope mapping of anti-BNP antibodies.

Capture	Detection
50E1cc	24C5cc
50E1cc	26E2
24C5cc	50B7cc
24C5cc	57H3cc
57H3cc	429cc
50E1cc	130cc
50E1cc	100cc
100cc	57H3cc

Table 1. Recommended MAb pairs for conventional BNP sandwich immunoassays. Data is based on the results obtained using our in-house time-resolved fluorescence immunoassay platform.

All of the recommended capture-detection pairs detect both the BNP peptide and the unprocessed proBNP protein with the same efficiency (see Figure 5 below). However, it is important to note that the cross-reactivity of commercial BNP assays to proBNP varies (18-20). All of the recommended combinations have been tested with the plasma samples of HF patients. As antibodies might display a varying performance on different assay platforms, we recommend trying at least four or five two-site MAb combinations when developing an immunoassay. This will ensure that a pair is selected which will perform optimally in the given assay conditions and platform.

As a standard for BNP immunoassays we recommend using the recombinant glycosylated proBNP (Cat.# 8GBP3, see p. 8) as the BNP-immunoreactivity in blood is predominantly represented by the glycosylated proBNP.

Calibration curves. All of the recommended BNP immunoassays recognize three BNP-comprising polypeptides with the same efficiency: synthetic BNP, recombinant non-glycosylated proBNP and recombinant glycosylated proBNP. Representative calibration curves for two sandwich fluoro-immunoassays 50E1-24C5 (A) and 57H3-429 (B) are presented in Figure 5. We have previously published a detailed description of the 50E1-24C5 immunoassay and shown that its analytical

sensitivity (with synthetic BNP used as a calibrator) in our in-house assay is better than 0.5 pg/ml (17). Other antibody pairs that are listed above also recognize BNP with extremely high sensitivity.

Hytest's BNP assays show good correlation with commercially available assays. BNP concentration was measured in 40 EDTA-plasma samples that were obtained from HF patients using two different in-house assays and two different commercial assays that utilize similar epitopes. In Figure 6 (A), we compared our 57H3-429 assay utilizing antibodies that were specific to epitopes 26-32 and 5-13 respectively to the Abbott iSTAT® BNP assay that utilizes antibodies with identical epitope specificities. The results of the measurements obtained with the BNP assay 57H3-429 correlated well with the results of measurements obtained with the Abbott iSTAT BNP assay ($R^2=0.99$). In Figure 6 (B), we compared our 50E1-130 assay (antibodies specific to epitopes 26-32 and 15-22 respectively) to the Siemens BNP assay that utilizes antibodies specific to epitopes 27-32 and 14-21. Our prototype assay 50E1-130 showed good correlation with the Siemens BNP assay ($R^2=0.97$).

Each assay was calibrated with internal standard material. The epitope specificities of the commercial assays are provided on the IFCC website www.ifcc.org.

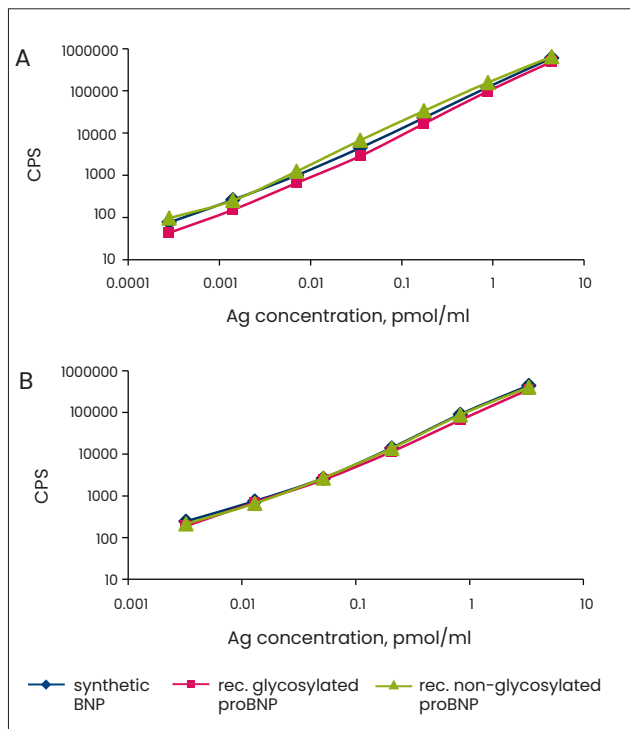

Figure 5. Calibration curves for 50E1 – 24C5 (A) and 57H3-429 (B) sandwich fluoroimmunoassays with three peptides that contain a BNP1-32 motif. Capture antibodies were biotinylated, while detection antibodies were labelled with Eu^{3+} . The antigens used were synthetic BNP (Bachem), recombinant non-glycosylated proBNP and recombinant glycosylated proBNP. A mixture of antibodies (50 μl) and antigen (50 μl) were incubated for 30 minutes at room temperature in streptavidin-coated plates.

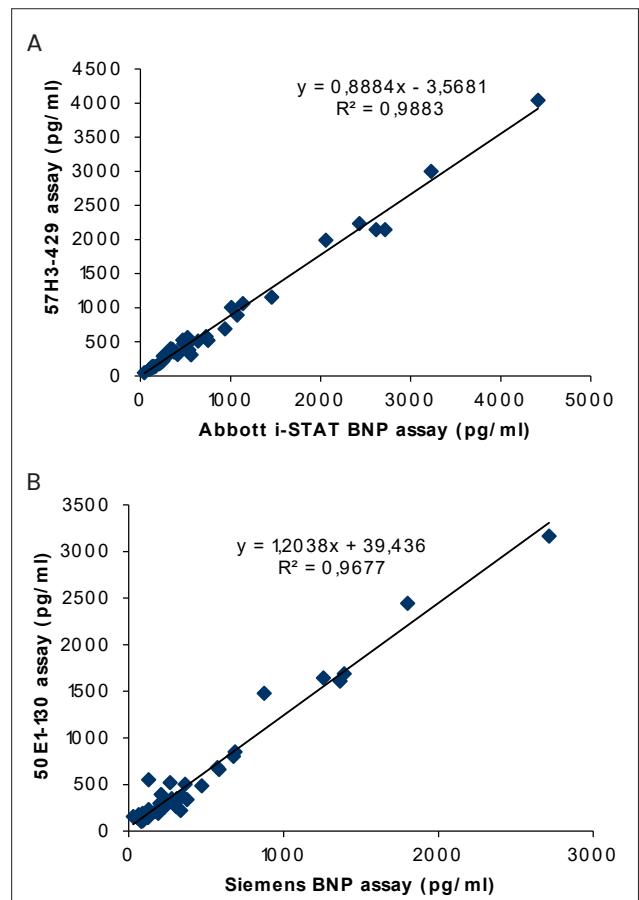

Figure 6. Hytest's immunoassays show good correlation with commercially available BNP assays.

Inhibition of neprilysin and its effect on BNP immunoassays

The augmentation of the endogenous BNP through preventing its breakdown by a neprilysin inhibitor is considered to be a potential therapeutic strategy in HF. Recently, a new HF drug named Entresto™ (Novartis) was approved by the Food and Drug Administration. One of the active components in this drug is a neprilysin inhibitor and it has been suggested that treatment with this drug might have an impact on the level of BNP-related peptides.

The majority of commercially available BNP assays are designed as sandwich-type immunoassays that utilize two MAbs which are specific to distantly located epitopes. At least one of these two antibodies is specific to the ring structure while the other one is usually specific to the C-terminus of the BNP molecule. As one of the neprilysin cleavage sites is located in the BNP ring structure (R17-I18; see Figure 2), it would be reasonable to suggest that immunoassays utilizing antibodies with epitopes comprising the neprilysin cleavage site would be sensitive to the proteolytic activity of neprilysin. However, the complexity of the biochemistry of the natriuretic peptides as well as the diversity of the different forms of heart failure mean that there is no straightforward answer to this question.

We have investigated the effect of neprilysin activity on various BNP immunoassays by studying the sensitivity of BNP and proBNP to neprilysin. According to our studies, it appears that although the BNP1-32 molecule was susceptible to the cleavage of neprilysin, the assay was resistant to the effect of neprilysin. This was likely due to the fact that the epitope which the capture antibody recognizes lies outside the neprilysin cleavage site. In comparison, an immunoassay with one of the antibodies specific to the epitope 14-21 containing the neprilysin cleavage site was sensitive to neprilysin as expected (21). We also found that the assay 57H3-429 pair is also resistant to the effect of neprilysin (data not shown).

We have also shown that the unprocessed proBNP, which is the main BNP immunoreactive form in blood, is actually not cleaved by neprilysin and therefore assays designed to only recognize proBNP should not be affected by drugs such as Entresto™ (21).

NT-PROBNP ASSAY DEVELOPMENT

NT-proBNP is the N-terminal portion of proBNP that consists of 76 amino acids and seven O-glycosylation sites. No biological activity has been found for NT-proBNP. Its half-life is 3-6 times longer than that of BNP, which means it is a somewhat more stable marker in clinical samples. The clinical value of NT-proBNP is similar to BNP. The calculated pI of NT-proBNP is 8.45 and molecular weight is 8.5 kDa. However, due to glycosylation its apparent molecular weight is higher (17).

Glycosylation influences the detection of NT-proBNP

Our studies have revealed that the glycosylation of NT-proBNP negatively affects its recognition by some antibodies. The central part of the NT-proBNP molecule (a.a.r. 28-56) is scarcely accessible for antibodies due to O-glycosylation, whereas regions 13-27 and 61-76 are well recognized.

In order to elucidate how glycosylation influences measurements of NT-proBNP, we analyzed plasma from eight HF patients both before and after deglycosylation with two assays; one utilizing antibodies that are specific to regions with no glycosylation sites (15C4-13G12) and one in which one of the antibodies is specific to a region with glycosylation sites (11D1-13G12). Figure 7 shows that deglycosylation has a dramatic effect on the latter assay.

The glycosylation and its effect on the detection of NT-proBNP should be taken into account during assay development. We recommend selecting antibodies that are less sensitive to glycosylation.

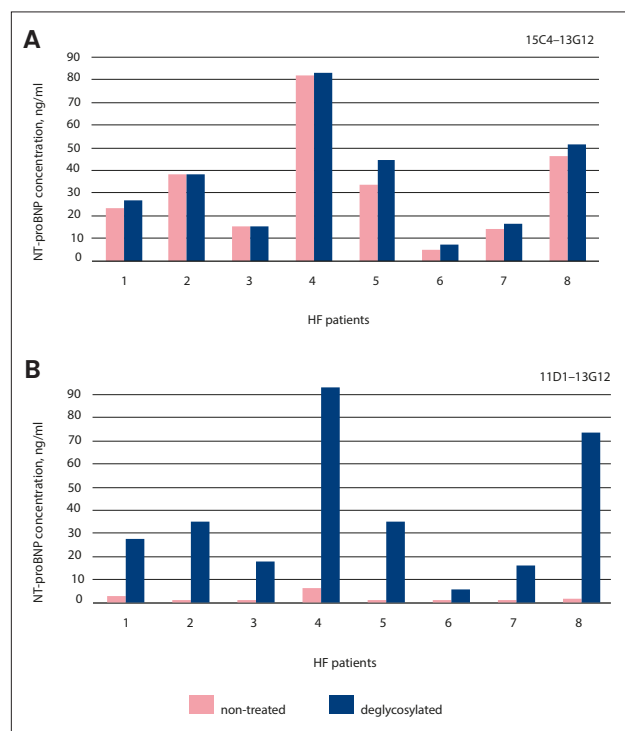

Figure 7. Glycosylation affects the detection of NT-proBNP to a varying degree depending on the assay antibodies. Plasma samples from eight HF patients were analyzed with two different sandwich immunoassays both before and after deglycosylation. The 15C4-13G12 immunoassay (A) gave almost the same result for glycosylated (light red) and deglycosylated (blue) NT-proBNP. In contrast, the MAb pair 11D1-13G12 was highly susceptible to glycosylation and could only detect the deglycosylated NT-proBNP.

NT-proBNP sandwich immunoassays

At Hytest, we provide several MABs that are specific to many different epitopes along the human NT-proBNP molecule (see Figure 8). Please note that the majority of the immunoassays that detect NT-proBNP also detect the unprocessed proBNP to some extent. We have thoroughly tested all of our NT-proBNP antibodies in sandwich immunoassays as capture and detection antibodies with blood samples from HF patients, as well as using our recombinant non-glycosylated NT-proBNP and proBNP as antigens. Based on our studies we recommend selecting antibodies that are specific to the epitopes outside the central, glycosylated region (see Table 2). These MAB pairs were able to detect both the endogenous and recombinant antigens with the same efficiency. In contrast, MAB pairs that utilized at least one MAB specific to the very N-terminal part of the analyte (a.a.r. 1-12) only detected the recombinant antigens. This was presumably due to the truncation of the endogenous NT-proBNP in samples. Immunoassays with MAB pairs utilizing an antibody specific to the central region of the analyte (a.a.r. 28-56) behaved the same way. The reason for this was because the epitopes were masked by glycans and therefore scarcely accessible to antibody binding.

As the antibody performance may differ depending on the assay conditions and platform, we recommend trying all two-site MABs combinations listed in Table 2 with a view to finding the best pair.

As a standard for NT-proBNP immunoassays we recommend using the recombinant non-glycosylated NT-proBNP (Cat.# 8NT2, see page 9). Antibodies that are specific to different regions of NT-proBNP recognize the non-glycosylated NT-proBNP expressed in *E. coli* with the same efficiency.

Calibration curves. All assays that utilize the recommended MAB combinations demonstrate high sensitivity (10–15 pg/ml), good kinetics and linearity. A representative calibration curve for the assay 15C4–13G12 is shown in Figure 9. For more information regarding this assay see Reference 17.

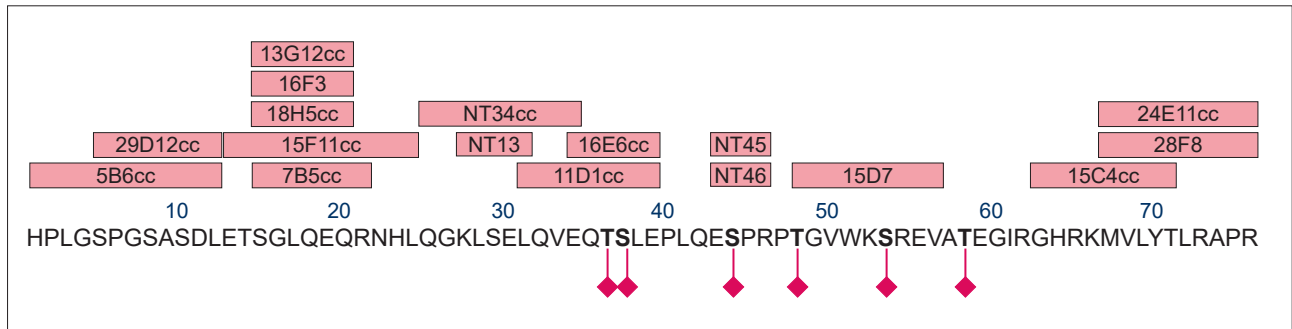

Figure 8. Schematic presentation of NT-proBNP molecule with identified glycosylation sites (red diamonds) and anti-NT-proBNP MABs with their epitopes.

Table 2. Recommended MAB pairs for NT-proBNP sandwich immunoassays. Data is based on the results obtained using our in-house time-resolved fluorescence immunoassay platform.

Capture	Detection	Capture	Detection
NT13	NT45	NT45	NT13
15C4cc	13G12cc	NT45	18H5cc
15C4cc	29D12cc	NT46	NT13
15F11cc	24E11cc	NT46	15F11cc
15C4cc	18H5cc	15F11cc	NT45
29D12cc	NT34cc	15F11cc	NT46

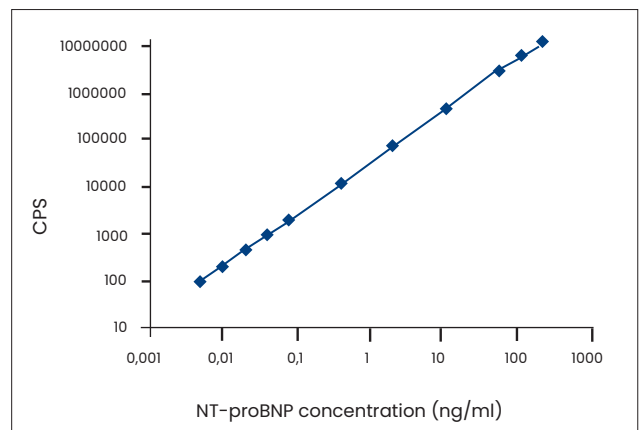

Figure 9. Calibration curve for the NT-proBNP 15C4-13G12 assay. The capture antibody 15C4 was biotinylated and the detection antibody 13G12 was labelled with Eu^{3+} . Human recombinant non-glycosylated NT-proBNP (Cat.# 8NT2) was used as the antigen. A mixture of antibodies (50 μl each) and antigen (50 μl) was incubated for 30 minutes at room temperature in streptavidin-coated plates.

Hytest's NT-proBNP assays show good correlation with commercially available assays. In Figure 10, we compared our NT13-NT45 assay utilizing antibodies that were specific to epitopes 27-31 and 43-46 respectively to the Roche Elecsys® proBNP assay. The results of the measurements obtained with the NT-proBNP assay NT13-NT45 correlated well with the results of measurements obtained with the Roche Elecsys proBNP assay ($R^2=0.99$).

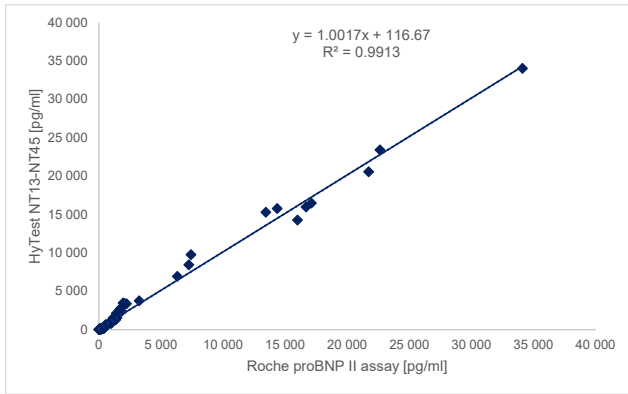

Figure 10.
Hytest's immunoassay shows good correlation with Roche Elecsys® proBNP assay.

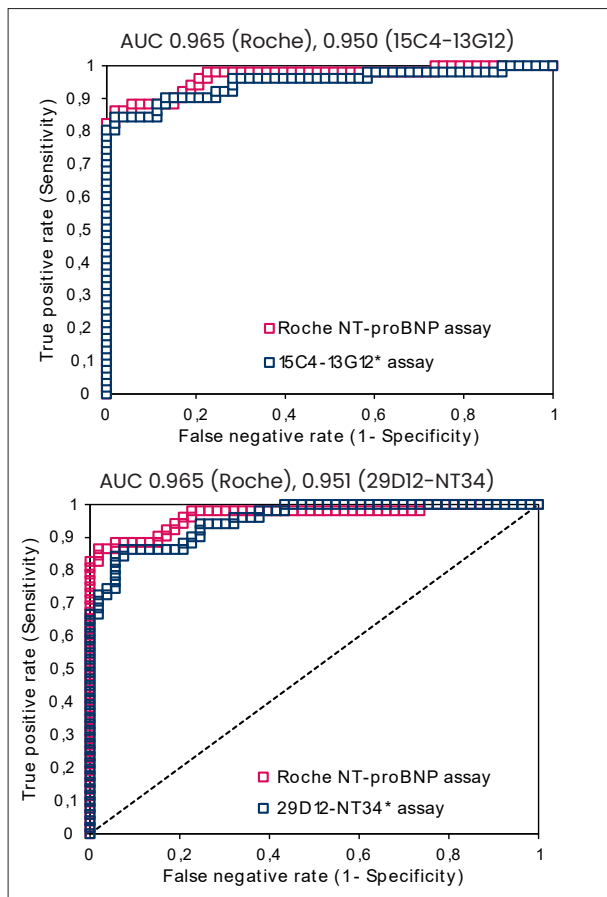

Figure 11.
ROC curves of NT-proBNP diagnostic accuracy in heart failure. Assessed with the Roche Cobas e411 assay and Hytest 15C4-13G12 assay (left) or Hytest 29D12-NT34 assay (right).

Hytest's NT-proBNP assay prototypes exhibit the same clinical value as the Roche NT-proBNP assay. The NT-proBNP concentrations were measured in EDTA-plasma samples from 51 patients who were diagnosed with HF and from 53 healthy individuals (age-matched) with the Roche Cobas® e411 analyzer and our in-house sandwich immunoassays 15C4-13G12 and 29D12-NT34. The diagnostic accuracies were compared using a ROC curve analysis. Our NT-proBNP assays are based on MAbs that are specific to the glycan-free regions of NT-proBNP whereas in the Roche assay one MAb is specific to the partially glycosylated region of NT-proBNP (epitope 42-46 a.a.r.). The Roche assay is known to detect only a subfraction of endogenous NT-proBNP as the assay is sensitive to glycosylation (22-24). The ROC-AUC for the Roche assay was 0.965 (sensitivity 0.86, specificity 0.98), 0.950 (sensitivity 0.84, specificity 0.98) for the 15C4-13G12 assay and 0.951 (sensitivity 0.86, specificity 0.93) for the 29D12-NT34 assay. So, the Hytest prototype assays were comparable to the Roche assay in regard to the clinical value (Figure 11).

Stability of the endogenous NT-proBNP in clinical samples. We analyzed the stability of NT-proBNP in serum samples from HF patients using the 15C4-13G12 immunoassay, in which both antibodies are specific to the stable part of the molecule (epitopes 63-71 a.a.r. and 13-20 a.a.r. respectively). More than 90% of the initial immunological activity was detected after 72 hours of incubation at +4°C and approximately 85-90% following incubation of the pooled serum for 24 hours at room temperature (see Figure 12). This indicates that if the immunoassay is designed with antibodies that recognize the stable parts of the molecule, it enables a reliable quantitation of the analyte from samples that have been stored at +4°C or even at room temperature for relatively long periods of time.

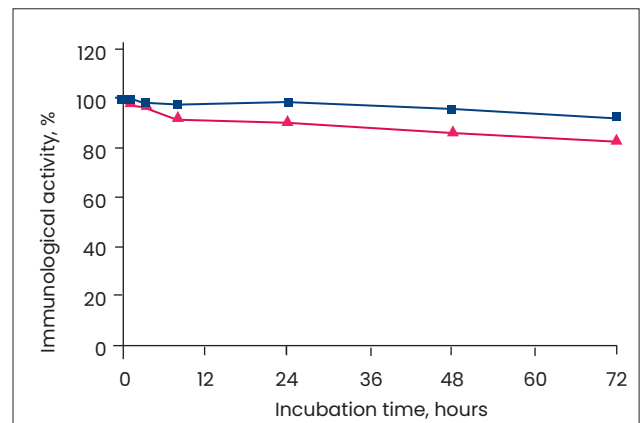

Figure 12.
Stability of endogenous NT-proBNP when measured with the 15C4-13G12 sandwich immunoassay. Pooled serum from patients with HF was incubated at +4°C (blue) and at room temperature (red) for 72 hours.

PROBNP ASSAY DEVELOPMENT

Both we and others have shown that in addition to NT-proBNP and BNP, their precursor proBNP1-108 is also found in significant amounts in the blood samples derived from HF patients (17, 25-26). The calculated pI of proBNP is 10.12 and molecular weight is 11.9 kDa. However, its apparent molecular weight is higher due to O-linked glycosylation (26).

The majority of the existing commercial BNP and NT-proBNP assays cross-react with proBNP to varying degrees. Such cross-reactivity might skew the correlation of BNP and NT-proBNP closer to proBNP.

The level of proBNP in blood has been shown to have a high degree of correlation with both BNP and NT-proBNP, and to allow the identification of HF patients with a high risk of cardiovascular death over a long term follow-up period (27). In another study it was shown that circulating proBNP levels were associated with an increased risk of adverse cardiovascular outcomes that were independent from BNP (28).

Assays that only detect proBNP1-108 might have an enhanced analytical specificity in comparison to the commercially available assays for the measurement of BNP and NT-proBNP.

ProBNP sandwich immunoassays

We have designed prototype proBNP immunoassays that utilize one antibody which is specific to an epitope on the BNP part of the molecule and one antibody that is specific to the NT-proBNP part. A schematic presentation of the suggested epitopes is shown in Figure 13 and the recommended MAb pairs are set out in Table 3. These pairs demonstrate high sensitivity, good kinetics and recognize recombinant glycosylated and non-glycosylated proBNP as well as proBNP in the blood of HF patients.

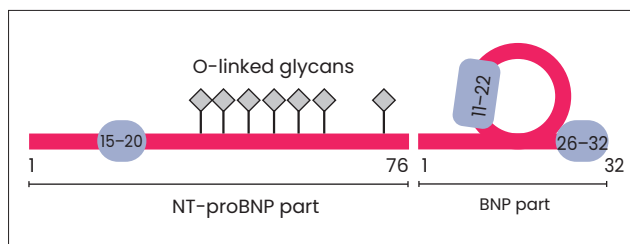

Figure 13. Epitope locations of MAbs that are recommended for the development of proBNP sandwich immunoassays.

Table 3. Recommended MAb pairs for proBNP sandwich immunoassays.

Capture	Detection
50E1cc	16F3
50E1cc	18H5cc

Calibration curves. The analytical sensitivity of the assay 50E1-16F3 using a recombinant non-glycosylated proBNP (Cat.# 8PRO9) as the calibrator is better than 3 pg/ml (see Figure 14).

RECOMBINANT PROTEINS

Recombinant glycosylated human proBNP

We provide recombinant proBNP expressed in a mammalian cell line (Cat.# 8GBP3). This protein is glycosylated and migrates in SDS-PAGE as a diffuse band with an apparent molecular mass between 20-25 kDa (see Figure 15). We recommend using the glycosylated proBNP as a standard for BNP and proBNP immunoassays.

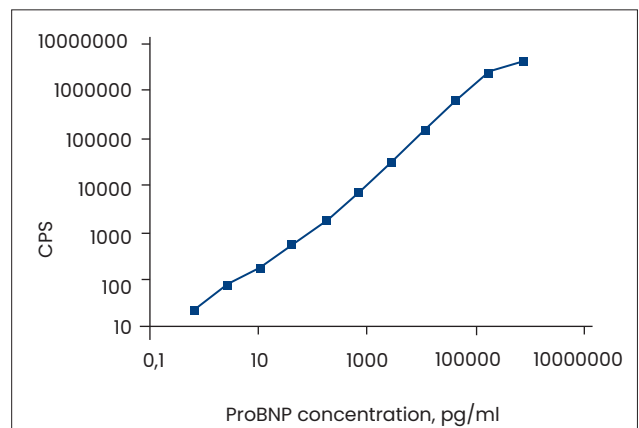

Figure 14. Calibration curve for the proBNP 50E1-16F3 sandwich immunoassay. The capture antibody 50E1 was biotinylated and the detection antibody 16F3 was labelled with Eu^{3+} . Recombinant non-glycosylated proBNP (Cat.# 8PRO9) was used as the antigen. A mixture of antibodies (50 μl each) and antigen (50 μl) was incubated for 30 minutes at room temperature in streptavidin-coated plates.

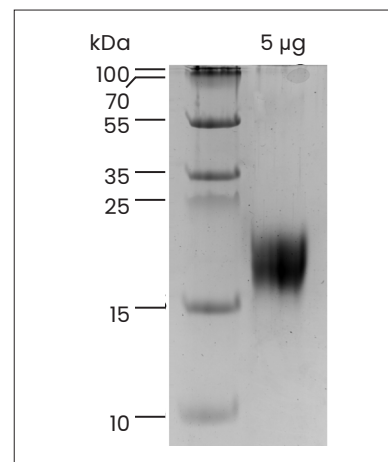

Figure 15. SDS-PAGE of recombinant glycosylated proBNP (Cat.# 8GBP3) in reducing conditions.

Glycosylated proBNP as a stable standard for BNP immunoassays. Plasma BNP concentrations measured by various commercial immunoassays differ substantially, which complicates the interpretation of the results. In addition to the different epitope specificities of the antibodies utilized in these assays, one factor that might contribute to these discrepancies could be the absence of a common calibrator.

In several BNP assays, synthetic BNP is currently used as a calibrator. However, a substantial part of the BNP immunoreactivity in clinical samples comes from glycosylated proBNP, which, however, is not equally recognized by different assays. On the other hand, the synthetic BNP is also relatively unstable when reconstituted in plasma and this limits its use as a calibrator in BNP immunoassays.

The advantage of recombinant glycosylated proBNP is its similarity to endogenous proBNP in terms of the presence of O-linked glycans as well as its better stability as compared to synthetic BNP. Figure 16 shows a comparison of stabilities of synthetic BNP, recombinant glycosylated proBNP and

endogenous proBNP (a plasma sample from an HF patient) measured with two representative BNP immunoassays. The recombinant glycosylated proBNP retained 90-96% of its immunoreactivity after 24 hours at room temperature, whereas the apparent stability of synthetic BNP was significantly lower.

Human recombinant (non-glycosylated) proBNP expressed in *E. coli*

Human recombinant proBNP (Cat.# 8PRO9; a.a.r. 1-108) is expressed in *Escherichia coli*. The polypeptide has the same sequence as the endogenous protein except for an additional Met residue at its N-terminus. The antigen is recognized by BNP-specific monoclonal antibodies (Cat.# 4BNP2) as well as by all NT-proBNP specific MABs (Cat.# 4NT1). ProBNP is highly purified, with purity exceeding 95% according to Tricine-SDS-PAGE (see Figure 17) and HPLC studies. The antigen could be used as either a calibrator or standard in BNP, NT-proBNP and proBNP immunoassays. The calibration curves with the non-glycosylated proBNP as the antigen are provided in Figure 5 for two conventional BNP immunoassays and in Figure 14 for a proBNP immunoassay.

Recombinant non-glycosylated NT-proBNP

Human recombinant NT-proBNP (Cat.# 8NT2; a.a.r. 1-76) is expressed in *Escherichia coli*. The polypeptide has the same sequence as the endogenous NT-proBNP except for an additional Met residue at the N-terminus. The antigen is recognized by MABs that are specific to different parts of NT-proBNP (Cat.# 4NT1).

The purity of NT-proBNP exceeds 95% according to Tricine-SDS-PAGE (see Figure 17) and HPLC studies. The antigen could be used as either a calibrator or standard in an NT-proBNP assay. The calibration curve with the recombinant NT-proBNP as the antigen is provided in Figure 9 for an NT-proBNP assay.

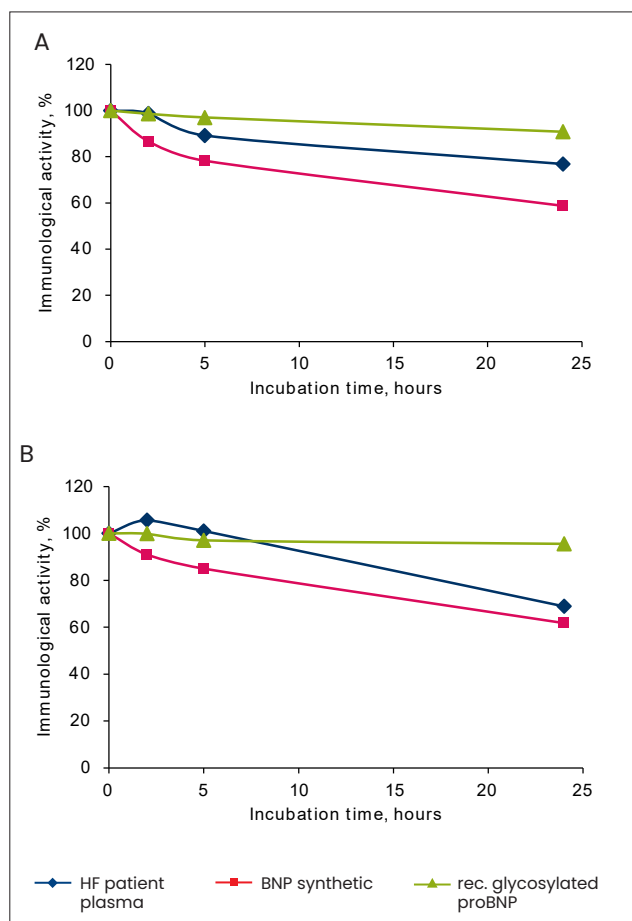

Figure 16. Stability of synthetic BNP vs. endogenous and recombinant glycosylated proBNP. Endogenous proBNP (plasma from HF patients – blue), recombinant glycosylated proBNP (green) and synthetic BNP (red) were reconstituted in pooled normal human EDTA-plasma and incubated at room temperature for different time periods. Immunological activity was measured with two BNP immunoassays: 50E1-24C5 (A) and 57H3-429 (B).

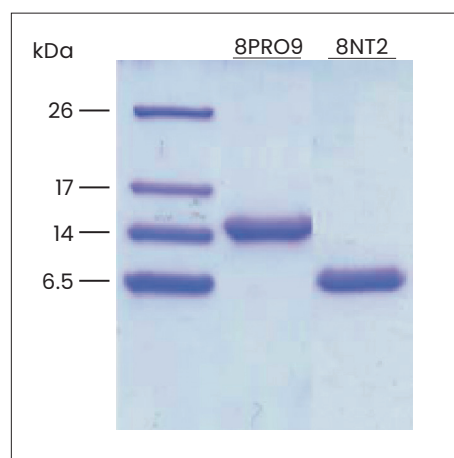

Figure 17. Tricine-SDS-PAGE in reducing conditions of rec. non-glycosylated proBNP (Cat.# 8PRO9) and NT-proBNP (Cat.# 8NT2). 3 µg of each protein was loaded into wells.

SELECTED PROBNP RELATED ARTICLES FROM HYTEST SCIENTISTS

Seferian KR, Tamm NN, Semenov AG, Mukharyamova KS, Tolstaya AA, Koshkina EV, Kara AN, Krasnoselsky MI, Apple FS, Esakova TV, Filatov VL, Katrukha AG. **The brain natriuretic peptide (BNP) precursor is the major immunoreactive form of BNP in patients with heart failure.** Clin Chem. 2007 May;53(5):866-873

In this study we describe the development of monoclonal antibodies that are specific to proBNP, NT-proBNP and BNP. Using carefully characterized immunoassays that are based on these antibodies as well as the Beckman Access BNP assay, we show that proBNP is the major antigen that contributes to BNP immunological activity in the blood of HF patients. We also demonstrate that the ratio of proBNP to BNP is significantly higher than previously thought.

Seferian KR, Tamm NN, Semenov AG, Tolstaya AA, Koshkina EV, Krasnoselsky MI, Postnikov AB, Serebryanaya DV, Apple FS, Murakami MM, Katrukha AG. **Immunodetection of glycosylated NT-proBNP circulating in human blood.** Clin Chem. 2008 May;54(5):866-873.

In this study we investigate how glycosylation affects the ability of NT-proBNP specific MAbs to recognize the molecule and demonstrate that O-linked glycosylation renders the central region of NT-proBNP scarcely accessible to antibody binding. This also applies to the Roche Elecsys 2010 NT-proBNP assay which utilizes polyclonal antibodies that are specific to epitopes partially covered by glycans, although the effect with the Roche assay is smaller. In addition, we show that the effect of glycosylation to detection by antibodies varies between patient samples, which indicates that the glycosylation pattern of NT-proBNP in samples is not identical and this can lead to unpredictable errors in measurements. Finally, we show that antibodies which are specific to N-terminal and C-terminal regions of NT-proBNP are less influenced by glycosylation and should therefore be considered when designing a quantitative NT-proBNP immunoassay.

Semenov AG, Postnikov AB, Tamm NN, Seferian KR, Karpova NS, Bloshchitsyna MN, Koshkina EV, Krasnoselsky MI, Serebryanaya DV, Katrukha AG. **Processing of pro-brain natriuretic peptide is suppressed by O-glycosylation in the region close to the cleavage site.** Clin Chem. 2009 Mar;55(3):489-498.

In this study we show that the processing of proBNP into NT-proBNP and BNP depends on the glycosylation of threonine residue at position 71 (Thr71) of proBNP. By investigating the immunoreactivity of endogenous NT-proBNP and proBNP in the plasma of HF patients through the use of a panel of

MAbs that are specific to different regions of the molecules, deglycosylation assays as well as alanine-scanning mutagenesis, we demonstrate that an O-linked glycan at Thr71 suppresses the cleavage of proBNP, whereas proBNP with Thr71 without a glycan is readily cleaved by proprotein convertase(s).

Semenov AG, Tamm NN, Seferian KR, Postnikov AB, Karpova NS, Serebryanaya DV, Koshkina EV, Krasnoselsky MI, Katrukha AG. **Processing of pro-B-type natriuretic peptide: furin and corin as candidate convertases.** Clin Chem. 2010 Jul;56(7):1166-1176.

In this article, we provide new information on proBNP processing mechanisms. Our data suggests the involvement of furin, and to a lesser extent corin, in the processing of proBNP into NT-proBNP and BNP. We show for the first time that a portion of endogenous proBNP in the plasma of HF patients lacks an attached glycan at Thr71 residue which normally makes proBNP susceptible to cleavage by convertase(s) into NT-proBNP and BNP. These findings improve our understanding of the different circulating forms of proBNP and its derivatives, as well as our comprehension of the cellular mechanisms of proBNP processing.

Semenov AG, Seferian KR. **Biochemistry of the human B-type natriuretic peptide precursor and molecular aspects of its processing.** Clin Chim Acta. 2011 May 12;412(11-12):850-60.

REVIEW. The aim of this review is to summarize the available data in the field of human proBNP maturation and processing, and to discuss potential clinical implications.

Semenov AG, Seferian KR, Tamm NN, Artem'eva MM, Postnikov AB, Bereznikova AV, Kara AN, Medvedeva NA, Katrukha AG. **Human pro-B-type natriuretic peptide is processed in the circulation in a rat model.** Clin Chem. 2011 Jun;57(6):883-90.

In this study we injected human proBNP into rats and used different BNP, NT-proBNP and proBNP immunoassays and mass spectrometry to analyze whether it could be processed in circulation. Our results indicate that proBNP can be cleaved in circulation, resulting in the formation of active BNP, which suggests that peripheral proBNP processing might be an important regulatory step rather than mere degradation.

Semenov AG, Katrukha AG. **Different Susceptibility of B-Type Natriuretic Peptide (BNP) and BNP Precursor (proBNP) to Cleavage by Nephilysin: The N-Terminal Part Does Matter.** Clin Chem. 2016 Apr;62(4):617-22.

In this article, we study the susceptibility of BNP and proBNP to proteolysis by nephilysin *in vitro*. Our data firstly suggested

that the major BNP immunoreactive form, proBNP, is resistant to degradation by neprilysin, and, secondly, the effect of neprilysin inhibition (e.g. by Entresto™, which is a recently approved heart failure drug containing a neprilysin inhibitor and an angiotensin II receptor inhibitor) might be assay dependent. We assume that BNP immunoassays utilizing antibodies specific to the region Arg17-Ile18 are more sensitive to the modulation of neprilysin activity than immunoassays with antibodies that do not have epitopes comprising this site.

Semenov AG, Katrukha AG. **Analytical Issues with Natriuretic Peptides – has this been Overly Simplified?** EJIFCC. 2016 Jul; 27(3): 189–207.

REVIEW. In this review, we summarize the recent advances in the understanding of the complexity of the natriuretic peptides system and discuss related analytical issues, which open new horizons, as well as challenges for clinical diagnostics.

Semenov AG, Tamm NN, Apple FS, Schulz KM, Love SA, Ler R, Feygina EE, Katrukha AG. **Searching for a BNP standard: Glycosylated proBNP as a common calibrator enables improved comparability of commercial BNP immunoassays.** Clin Biochem. 2017 Mar;50(4-5):181-185.

In this study our researchers, in collaboration with Prof. Fred S. Apple and his team, compared six different recombinant BNP-related proteins in order to find out if any of them would reduce the between-assay variability of five commercial BNP assays. Based on the findings in this study, it was determined that one form of glycosylated proBNP could be a good candidate to serve as a common calibrator for BNP immunoassays in order to reduce the between-assay variability.

Li L, Semenov AG, Feygina EE, Yang CC, Wang N, Chen C, Hu X, Ni X and Zhang Z. **Diagnostic utility of total NT-proBNP testing by immunoassay based on antibodies targeting glycosylation-free regions of NT-proBNP.** Clin Chem Lab Med. 2022 Dec; 61 (3):485-493

In this study, our researchers collaborated with Dr Zhenlu Zhang and his team from Wuhan Asia Heart hospital to study the diagnostic utility of immunoassays measuring total NT-proBNP. Our study showed that the clinical value of total NT-proBNP for HF diagnosis was similar to the subfraction of NT-proBNP that was non-glycosylated at Ser44. However, the lower percentage of non-glycosylated NT-proBNP to total NT-proBNP in non-HF patients suggests that total NT-proBNP might be more sensitive in individuals without current or prior symptoms of HF. We suppose that the total NT-proBNP concentration assessment might reflect the real condition of cardiac stress and be valuable to evaluate the long-term prognosis or risk for patients.

HYTEST'S PATENTS AND TRADEMARKS

Immunoassay Kit for Quantification of BNP and proBNP (US 9,145,459).

Stable Standards for BNP Immunoassays (EP 2084544, CN 101641601, CA 2669024).

Immunoassay for Quantification of an Unstable Antigen Selected from BNP and proBNP (US 9,034,591, US 9,034,592, JP 5686593, CN 101842707, CA 268391, EP 2135087).

REFERENCES

1. **Benjamin, EJ et al.** Heart disease and stroke statistics – 2017 update. *Circulation*. 2017, 135 (10): e146-e603.
2. **Emdin, M et al.** Comparison of brain natriuretic peptide (BNP) and amino-terminal ProBNP for early diagnosis of heart failure. *Clin Chem*. 2007, 53: 1289-1297.
3. **Mueller, T et al.** Diagnostic accuracy of B type natriuretic peptide and amino terminal proBNP in the emergency diagnosis of heart failure. *Heart*. 2005, 91: 606-612.
4. **Ponikowski, P et al.** 2016 ESC Guidelines for the diagnosis and treatment of acute and chronic heart failure. *Eur. Heart J*. 2016, 37: 2129–2200.
5. **Schellenberger, U et al.** The precursor to B-type natriuretic peptide is an O-linked glycoprotein. *Arch Biochem Biophys*. 2006, 451: 160-166.
6. **Semenov, AG et al.** Processing of proBNP is suppressed by O-glycosylation in the region close to the cleavage site. *Clin Chem*. 2009, 55(3): 489-498.
7. **Mair, J et al.** The impact of cardiac natriuretic peptide determination on the diagnosis and management of heart failure. *Clin Chem Lab Med*. 2001, 39: 571-588.
8. **Cowie, MR and Mendez, GF.** BNP and congestive heart failure. *Prog Cardiovasc Dis*. 2002, 44: 293-321.
9. **Pandey, KN.** Biology of natriuretic peptides and their receptors. *Peptides*. 2005, 26: 901-932.
10. **Belenky, A et al.** The effect of class-specific protease inhibitors on the stabilization of B-type natriuretic peptide in human plasma. *Clin Chim Acta*. 2004, 340: 163-172.
11. **Murdoch, DR et al.** Disparity between studies of the stability of BNP in blood: comparison of endogenous and exogenous peptide. *Heart*. 1999, 81: 212-213.
12. **Niederkofer, EE et al.** Detection of endogenous B-type natriuretic peptide at very low concentrations in patients with heart failure. *Circ. Heart Fail*. 2008, 1(4): 258-264.
13. **Brandt, I et al.** Dipeptidyl-peptidase IV converts intact B-type natriuretic peptide into its des-SerPro form. *Clin Chem*. 2006, 52(1): 82-87.
14. **Pankow, K et al.** Successive action of meprin A and neprilysin catabolizes B-type natriuretic peptide. *Circ Res*. 2007, 101(9): 875-882.
15. **Müller, D et al.** Rat insulin-degrading enzyme: cleavage pattern of the natriuretic peptide hormones ANP, BNP, and CNP revealed by HPLC and mass spectrometry. *Biochemistry*. 1992, 31(45): 11138-11143.
16. **Ralat, LA et al.** Insulin-degrading enzyme modulates the natriuretic peptide-mediated signaling response. *J Biol Chem*. 2011, 286(6): 4670-4679.
17. **Seferian, KR et al.** The brain natriuretic peptide (BNP) precursor is the major immunoreactive form of BNP in patients with heart failure. *Clin Chem*. 2007, 53: 866-873.
18. **Luckenbill, KN et al.** Cross-reactivity of BNP, NT-proBNP, and proBNP in commercial BNP and NT-proBNP assays: preliminary observations from the IFCC Committee for Standardization of Markers of Cardiac Damage. *Clin Chem*. 2008, 54(3): 619-621.
19. **Semenov, AG et al.** Searching for a BNP standard: glycosylated proBNP as a common calibrator enables improved comparability of commercial BNP immunoassays. *Clin Biochem*. 2017, 50: 181-185.
20. **Saenger, AK et al.** Specificity of B-type natriuretic peptide assays: cross-reactivity with different BNP, NT-proBNP, and proBNP peptides. *Clin Chem*. 2017, 63(1): 351-358.
21. **Semenov, AG and Katrukha, AG.** Different susceptibility of B-type natriuretic peptide (BNP) and BNP precursor (proBNP) to cleavage by neprilysin: the N-terminal part does matter. *Clin Chem*. 2016, 62(4): 617-622.
22. **Seferian, KR et al.** Immunodetection of glycosylated NT-proBNP circulating in human blood. *Clin Chem*. 2008, 54: 866-873.
23. **Nishikimi, T et al.** The effect of glycosylation on plasma N-terminal proBNP-76 levels in patients with heart or renal failure. *Heart*. 2012, 98(2): 152-161.
24. **Røsjø, H et al.** Influence of glycosylation on diagnostic and prognostic accuracy of N-terminal pro-B-type natriuretic peptide in acute dyspnea: data from the Akershus Cardiac Examination 2 Study. *Clin Chem*. 2015, 61(8): 1087-1097.
25. **Giuliani, I et al.** Assay for measurement of intact B-type natriuretic peptide prohormone in blood. *Clin Chem*. 2006, 52: 1054-1061.
26. **Liang, F et al.** Evidence for functional heterogeneity of circulating B-type natriuretic peptide. *J Am Coll Cardiol*. 2007, 49: 1071-1078.
27. **Waldo, SW et al.** Pro-B-type natriuretic peptide levels in acute decompensated heart failure. *J Am Coll Cardiol*. 2008, 51: 1874-1882.
28. **Dries, DL et al.** Simultaneous assessment of unprocessed proBNP1-108 in addition to processed BNP32 improves identification of high-risk ambulatory patients with heart failure. *Circ Heart Fail*. 2010, 3(2): 220–227.

ORDERING INFORMATION

MONOCLONAL ANTIBODIES

Product name	Cat. #	MAB	Subclass	Remarks
BNP	4BNP2	26E2	IgG1	EIA, WB, a.a.r. 11-22
	4BNP2cc	429cc	IgG1	<i>In vitro</i> , EIA, a.a.r. 5-13
		100cc	IgG2a	<i>In vitro</i> , EIA, a.a.r. 10-15
		24C5cc	IgG1	<i>In vitro</i> , EIA, WB, a.a.r. 11-17
		130cc	IgG1	<i>In vitro</i> , EIA, a.a.r. 15-22
		50E1cc	IgG1	<i>In vitro</i> , EIA, WB, a.a.r. 26-32
		50B7cc	IgG2a	<i>In vitro</i> , EIA, WB, a.a.r. 26-32
		57H3cc	IgG2a	<i>In vitro</i> , EIA, WB, a.a.r. 26-32
Immune complex (24C5-BNP/proBNP)	4BFab5	Ab-BNP4	IgG2a	EIA (only as pair with MAb 24C5cc, Cat.# 4BNP2cc)
	4BFab5cc	Ab-BN- P2cc	IgG2a	<i>In vitro</i> , EIA (only as pair with MAb 24C5cc, Cat.# 4BNP2cc)
NT-proBNP	4NT1	16F3	IgG1	EIA, WB, a.a.r. 15-20
		15D7	IgG1	EIA, WB, a.a.r. 48-56
		28F8	IgG2a	EIA, WB, a.a.r. 67-76
	4NT1cc	5B6cc	IgG1	<i>In vitro</i> , EIA, WB, a.a.r. 1-12
		29D12cc	IgG2a	<i>In vitro</i> , EIA, WB, a.a.r. 5-12
		15F11cc	IgG2b	<i>In vitro</i> , EIA, WB, a.a.r. 13-24
		13G12cc	IgG2a	<i>In vitro</i> , EIA, WB, a.a.r. 15-20
		18H5cc	IgG1	<i>In vitro</i> , EIA, WB, a.a.r. 15-20
		7B5cc	IgG1	<i>In vitro</i> , EIA, WB, a.a.r. 15-21
		NT34cc	IgG1	<i>In vitro</i> , EIA, WB, a.a.r. 25-34
		NT13	IgG	EIA, LF, a.a.r. 27-31, recombinant rabbit antibody
		11D1cc	IgG1	<i>In vitro</i> , EIA, WB, a.a.r. 31-39
		16E6cc	IgG1	<i>In vitro</i> , EIA, WB, a.a.r. 34-39
		15C4cc	IgG2b	<i>In vitro</i> , EIA, WB, a.a.r. 63-71
		NT45	IgG	EIA, LF, a.a.r. 43-46, recombinant rabbit antibody
		NT46	IgG	EIA, LF, a.a.r. 43-46, recombinant rabbit antibody
		24E11cc	IgG2a	<i>In vitro</i> , EIA, WB, a.a.r. 67-76

ANTIGENS

Product name	Cat. #	Purity	Source
NT-proBNP, recombinant	8NT2	>95%	Recombinant
ProBNP, recombinant	8PRO9	>95%	Recombinant
ProBNP, glycosylated, recombinant	8GBP3	>95%	Recombinant

DEPLETED PLASMA

Product name	Cat. #	Source
BNP and NT-proBNP free plasma	8BFP	Pooled normal human plasma

Please note that the results shown in this TechNotes have been obtained using *in vivo* produced monoclonal antibodies. MAbs produced in cell culture are expected to have a similar performance as the *in vivo* produced MAbs.